



# DXR-8

Wireless Digital Video  
Monitoring System



See closer. See more. See everywhere.

User Manual

English (US)  
[www.infantoptics.com](http://www.infantoptics.com)

# Table of contents

<b>1. Safety Instructions</b> .....	2
<b>2. Overview</b> .....	3
2.1 What's Included.....	3
2.2 Product Overview.....	4
2.3 Menu Options .....	5
<b>3. Getting Started</b> .....	6
3.1 Powering Camera Unit.....	6
3.2 Wall Mounting Camera Unit.....	6-7
3.3 Monitor Unit Battery Installation.....	7
3.4 Charging and Powering the Monitor Unit.....	7-8
3.5 Registration (Pairing).....	8-9
3.6 Temperature Scale Display Setting .....	9
<b>4. Using the Infant Optics DXR-8 Monitor</b> .....	10
4.1 Set Up.....	10
4.2 Pan and Tilt.....	10
4.3 Night Vision Mode.....	10
4.4 Talk Mode.....	10
4.5 Sleep Mode (Video OFF with Audio ON).....	10
<b>5. DXR-8 Monitor Unit Menu Options</b> .....	11
5.1 Volume.....	11
5.2 Brightness.....	11
5.3 Sleep Mode Delay (Video OFF, Audio ON).....	12
5.4 Digital Zoom.....	12
5.5 Alarm.....	12
5.6 Camera Control.....	12
5.6.1 Delete a Camera.....	12-13
5.6.2 Add (pair) a Camera.....	13
5.6.3 View a Camera.....	13
5.6.4 Scan Camera.....	14
5.7 Warning Volume Setting.....	14
<b>6. Using Optical Lens</b> .....	15
6.1 Aluminum Lens Hood.....	15
6.2 Optical Zoom Lens.....	15
6.3 Optical Wide Angle Lens.....	15
6.4 Cleaning your Optical Lens.....	16
<b>7. Troubleshooting</b> .....	17-19
<b>8. Specifications</b> .....	20
<b>9. FCC Regulations</b> .....	21
<b>10. Warranty Information</b> .....	22

# 1. Safety Instructions

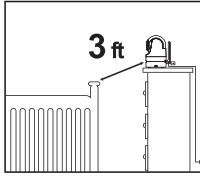

## WARNING:

- **STRANGULATION HAZARD** – Children have **STRANGLED** in cords. Keep this cord out of the reach of children (more than 3 ft (1m) away).
- **NEVER PLACE THE CAMERA OR CORD IN OR NEAR CRIB OR PLAYPEN.** Secure the cord at least three feet away from crib or playpen.
- **CHOKING HAZARD** – This product contains small parts which may cause choking, including the Optical Lens and Lens Hood.
- **SHOCK WARNING** – To prevent electric shock, **NEVER** use the transmitter or receiver near water, including near a bathtub, sink, laundry tub, wet basement, etc.
- **CAUTION** – Only insert a battery pack of the same type. Risk of explosion if battery is replaced with an incorrect type.
- Use only the AC adapters provided.
- Adult assembly is required. Keep small parts away from children when assembling.
- This product is not a toy. Do not allow children to play with it.
- This product is **NOT** intended to replace proper adult supervision of children.
- You **MUST** check your child's activity regularly, as this product will not alert parents to silent activities of a child.
- Before using this product, read and follow all instructions and warnings contained in this booklet.
- This product is intended for indoor use only.
- This product is not intended for use as a medical monitor and its use should not replace adult supervision.
- Test monitor before use and after changing camera location. Check reception regularly. Obstacles, such as concrete walls, may shorten the wireless signal transfer range.
- Always unplug AC adapters from wall outlets and power sources during periods of non-use.
- Do not touch the plug contacts with sharp or metal objects.
- Do not allow water damage to the monitor unit, charging port, or charging cable which cause overheat of the charging components.
- Do not use unofficial third party charging cables to charge the device. This may result in overheat of the charging port. Only use the charging cables provided in the box.
- Do not use unofficial third party power adapters, especially high wattage adapters. This may result in overheat of the cable and/or charging port. Only use the adapter provided in the box.

## 2. Overview

### 2.1 What's Included

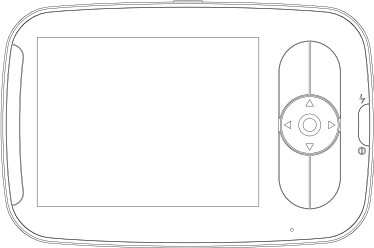

Monitor Unit

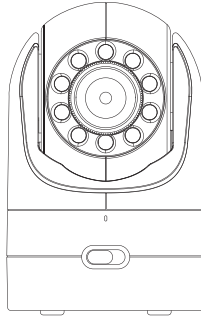

Camera Unit  
(with Aluminum Lens Hood)

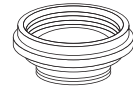

1x Optical Zoom Lens

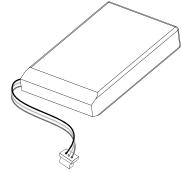

1x Rechargeable  
Lithium Ion Battery

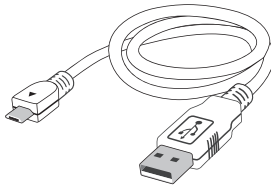
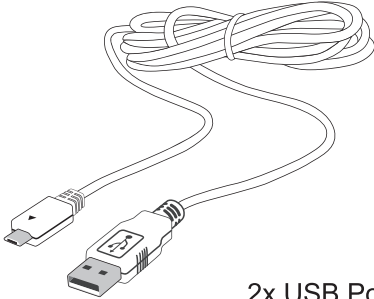

2x USB Power Cables  
(10' in length, and 3' in length)

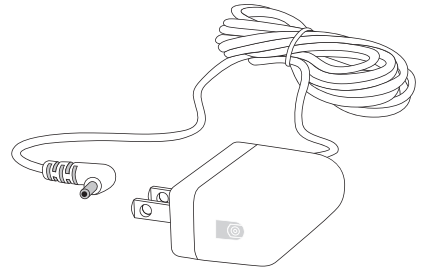

1x Camera Power Adapter

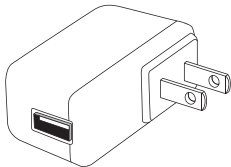

1x USB Output Adapter

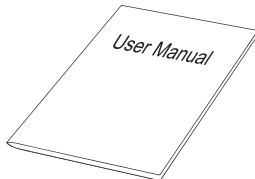

User Manual

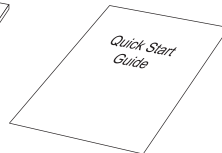

Quick Start Guide



Screw and Anchor



## 2.2 Product Overview

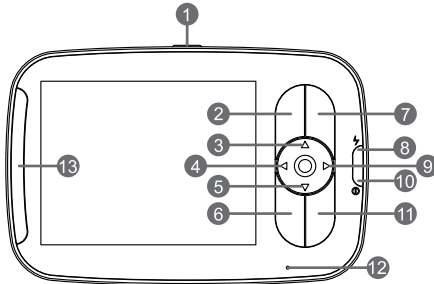



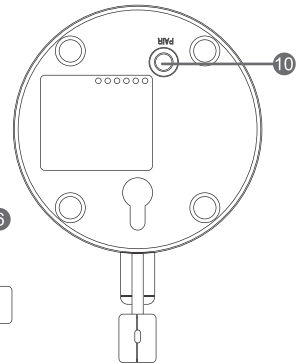
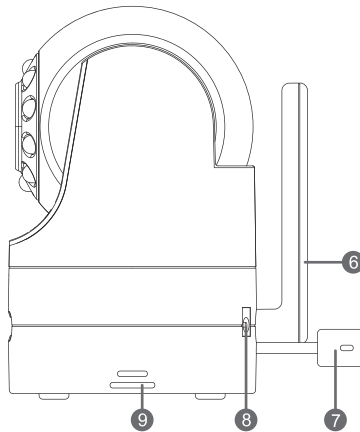
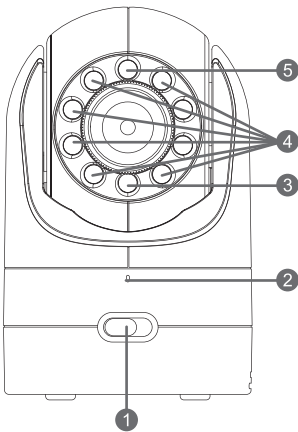
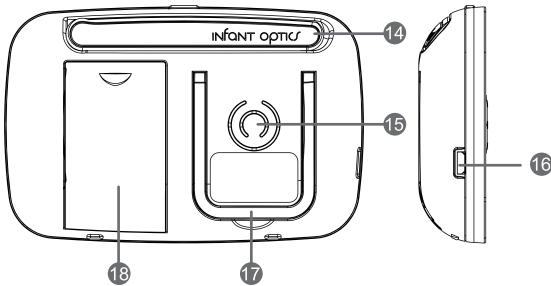

1. Power ON/OFF/SLEEP Button
2. MENU Button
3. UP Button
4. LEFT Button
5. DOWN Button
6. SHORT-CUT Button
7. OK Button
8. Charging LED Indicator
9. RIGHT Button
10. Power LED Indicator
11. TALK Button
12. Microphone
13. Volume Level LED
14. Antenna
15. Speaker
16. USB DC Jack
17. Stand
18. Battery Compartment









1. ON/OFF Switch
2. Microphone
3. Power LED
4. Infrared LEDs
5. Photo Sensor (Night Vision Mode)
6. Antenna
7. Temperature Sensor
8. DC Jack
9. Speaker
10. PAIR Key

## 2.3 Menu Options

### Status Indication Overview (Upper Screen Bar)

Icon	Description	Options
	Signal Strength Indicator	5 levels
cam 1 / cam 2 / cam 3 / cam 4	Camera Selected	cam1 / cam2 / cam3 / cam4 / scan(x)
	Night Vision	(on / off)
	Alarm Setting	(on / off)
	Talk-back	(on / off)
°C / °F	Current Camera Unit Temperature	1-36 °C / 34-97 °F
	Battery Power	4 levels, or flashing red (low battery)

### Menu Options Overview (Lower Screen Bar)

Icon	Description	Options
	Volume	8 levels
	Screen Brightness	8 levels
	Sleep Mode Delay	3min, 5min, off
	Digital Zoom	1X, 2X
	Alarm Setting	off, 2h, 4h, 6h
	Camera Options	del, add, view, scan
	Warning Volume	high / low / off

## 3. Getting Started

### 3.1 Powering Camera Unit

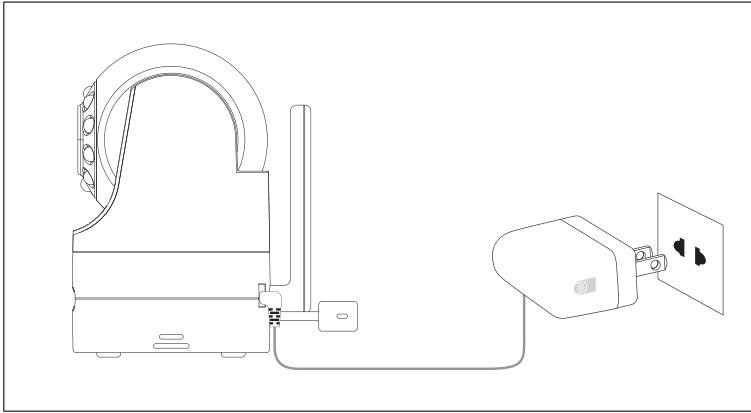

1. Connect the Camera Power Adapter to the Camera Unit.
2. Slide the ON/OFF Switch to the On position. The Power LED light on the Camera Unit will illuminate green.
3. Position your Camera Unit no less than 3 feet away from your baby's crib. Ensure the power cord is not within reach of your baby.

#### NOTE

Only use the enclosed Camera Power Adapter (5.9V DC / 1000mA).

### 3.2 Wall Mounting Camera Unit

Before installation, check the reception and camera positioning of the location you intend to mount the camera by holding it to the wall. Ensure the desired location is no less than 3 feet away from your baby's crib.

1. Pre-drill a hole in the wall using a 1/5 inch (6mm) drill bit.
2. Insert wall anchor into the wall and tap gently with a hammer until the anchor is flush with the wall.
3. Insert screw into the wall anchor and tighten until the screw only sticks out by about 1/3 inch.
4. Connect the Camera Power Adapter to the Camera Unit.

5. Locate the hole on the bottom of the Camera Unit and slide the hole over the screw sticking out of the wall.
6. Check to see that the Camera Unit is secure. If it is loose, you may need to tighten the screw more.
7. Use wall clips (not included) to secure the power cord away from the crib or baby's reach.

### 3.3 Monitor Unit Battery Installation

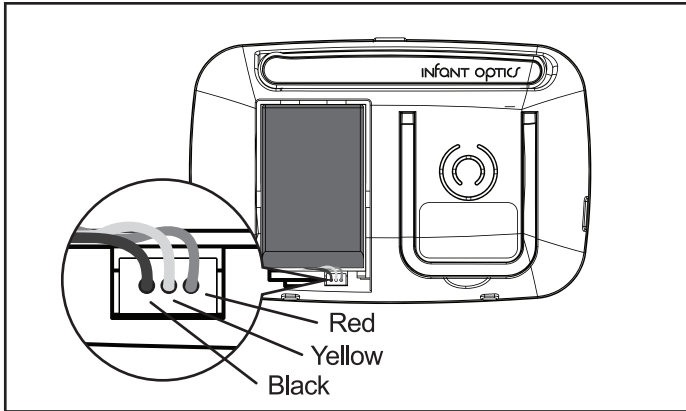



1. Insert the Rechargeable Li-ion Battery into the Battery Compartment as shown above.
2. Insert the wire tab of the Rechargeable Li-ion Battery into the contact slots as shown above.
3. Replace the battery cover over the compartment.

### 3.4 Charging and Powering the Monitor Unit

For best results, charge the Monitor Unit before use. After the initial charge, recharge normally as required. The Monitor Unit can be operated normally with power adapter plugged into the unit with the battery installed.

2x (two) USB Power Cables are included in the box. We provide two Power Cables so that you can have an additional charging point for your Monitor Unit. We recommend that you use the shorter cable (3') for your computer/laptop, and the longer cable (10') for your night stand.

1. Fit either one of the USB Power Cables into the USB outlet of the USB Output Adapter. Plug the USB Output Adapter into the electrical outlet. Connect the small end of USB Power Cable to the USB DC Jack of the Monitor Unit.
2. Press and hold the  POWER ON/OFF/SLEEP button for 2 seconds to turn ON the Monitor Unit. The POWER LED indicator will illuminate green to indicate the unit is ON.
3. Once both the Camera and Monitor Units are switched on, the display on the Monitor Unit will show the video captured by the Camera Unit.
4. If there is no connection or you are out of range, the video display will go off and the screen **WARNING: Out of signal coverage** will be shown on the LCD display. The unit will also beep every 30 seconds. Move the Monitor Unit closer to the Camera Unit until the link is re-established.
5. Press and hold the  POWER ON/OFF/SLEEP button, until the progress bar finishes scrolling, to turn OFF the Monitor Unit.

#### NOTE

The  battery icon turns red on the LCD screen to indicate that the battery is low, and it gives a beep periodically. The battery needs to be recharged. Fully charging the battery takes about 7 hours.

#### When Charging





1. During power OFF, when adapter is plugged in, an adapter logo will display on screen and the Charging LED Indicator will illuminate red to indicate charging, then turn blue to indicate that the battery is fully charged.
2. During power ON, when adapter is plugged in, the  battery icon on screen's top right corner will show that the battery is charging. The Charging LED Indicator will also illuminate red to indicate charging, then turn blue to indicate that the battery is fully charged.

#### NOTE

You can use the Monitor Unit while it is being charged.

### 3.5 Registration (Pairing)

The Camera Unit is pre-registered to your Monitor Unit. You do not need to register it again unless the Camera Unit loses its link with the Monitor Unit. To re-register your Camera Unit, or register a new Camera Unit, follow the procedure below:

1. Press the MENU button of the Monitor Unit and the menu bar will pop up.
2. Press the  LEFT button or  RIGHT button until  Cam icon is highlighted,
3. Press the  UP button or  DOWN button until **ADD** icon is highlighted and press the OK button.

4. Press the ▲ UP button or ▼ DOWN button to select the desired CAM and press the OK button to start searching for a Camera Unit.
5. Press and hold the PAIR key underneath the Camera Unit for at least 3 seconds. The power LED light (green LED light, located directly below the camera lens aperture) should flash green to indicate the Camera Unit is in pairing mode. If it does not flash, press and hold the PAIR key until the LED light flashes.
6. If unsuccessful, delete the camera channel as per 5.6.1 on page 12, and attempt to pair again.

#### NOTE

If a particular Camera Unit was previously registered with another Monitor Unit, registering with the current Monitor Unit will overwrite the old registration on the Camera Unit.

## 3.6 Temperature Scale Display Setting

The temperature reading from the temperature sensor at the back of the Camera Unit will be displayed on the top of the screen. To toggle between °C and °F :

1. Press and hold the SHORT-CUT button for more than 3 seconds.
2. Check that the temperature display reading on the screen has changed to your desired scale. If not, repeat step 1.

## 4. Using the Infant Optics DXR-8 Monitor

### 4.1 Set Up

Place the Camera Unit in a convenient location (e.g. on a table or a shelf) and point the camera lens toward the area you want to monitor.

#### NOTE

Do not place the Monitor Unit within baby's reach. If there is interference with the picture or sound, try moving the units to different locations, and ensure they are not close to other electrical equipment.

### 4.2 Pan and Tilt

The Camera Unit can be remotely controlled from the Monitor Unit.

1. Press  UP button or  DOWN button to tilt upward or downward.
2. Press the  LEFT button or  RIGHT button to pan left or right.



### 4.3 Night Vision Mode

The Camera Unit has 8 high-intensity infrared LEDs for picking up clear images in the dark. When the built-in photo sensor detects a low level of ambient light, the LEDs will automatically activate and the screen on the Monitor Unit will display in black and white. The  icon will be displayed on the screen.

### 4.4 Talk Mode

Press and hold the  TALK button on the Monitor Unit to talk to your baby through the Camera Unit's loudspeaker. A  icon will be displayed at the top of the LCD screen.

### 4.5 Sleep Mode (Video OFF with Audio ON)

Short press the  POWER ON/OFF/SLEEP button to turn the LCD screen OFF while keeping the audio ON. This mode conserves power. Short press the  POWER ON/OFF/SLEEP button to turn screen back on.

## 5. DXR-8 Monitor Unit Menu Options

### 5.1 Volume

1. Press the MENU button and the menu bar will pop up.
2. Press the ◀ LEFT button or ▶ RIGHT button until 🔊 Volume icon is highlighted.
3. Press the ▲ UP button or ▼ DOWN button to select the desired volume level from level 1 ~ 8 (The default volume level setting is level 4). Level 0 is mute.

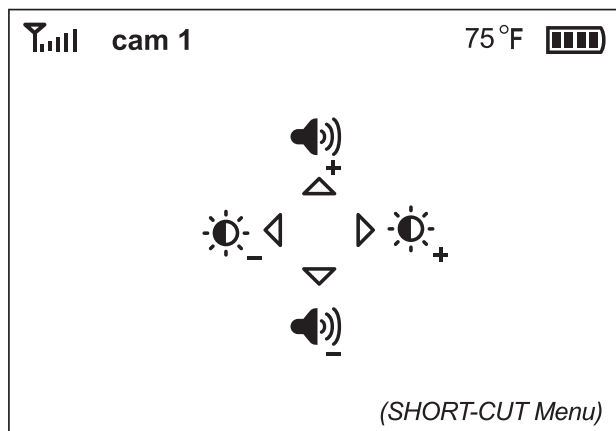

#### TIP: SHORT-CUT Menu

This product offers a quick shortcut menu. This is useful when you are sleeping and want to adjust the volume or brightness quickly, without the need to enter into the menu bar. Press the SHORT-CUT button on the Monitor Unit. Do not hold the button down as this will toggle the temperature scale reading. The menu bar (image above) will appear. Press the ◀ LEFT and ▶ RIGHT button to adjust brightness, or ▲ UP and ▼ DOWN button to adjust volume. This menu bar will disappear in 5 seconds if no button is pressed.

### 5.2 Brightness

1. Press the MENU button and the menu bar will pop up.
2. Press the ◀ LEFT button or ▶ RIGHT button until ☀ Brightness icon is highlighted.
3. Press the ▲ UP button or ▼ DOWN button to select the desired brightness level from level 1 ~ 8 (The default brightness level setting is level 4).



## 5.3 Sleep Mode Delay (Video OFF, Audio ON)

This sets the delay time for the screen to turn off automatically (entering SLEEP MODE).

1. Press the MENU button and the menu bar will pop up.
2. Press the ◀ LEFT button or ▶ RIGHT button until  Standby icon is highlighted.
3. Press the ▲ UP button or ▼ DOWN button to select the desired time from 3min, 5min and OFF. (The default AUTO sleep setting is 5min)
4. Press OK to select the desired delay time.

## 5.4 Digital Zoom

This product offers digital zoom. Please see more on the next section of this user manual to learn how to use optical zoom with digital zoom.

1. Press the MENU button and the menu bar will pop up.
2. Press the ◀ LEFT button or ▶ RIGHT button until  Digital Zoom icon is highlighted.
3. Press ▲ UP button or ▼ DOWN button to select desired digital zoom 1X or 2X. (Default setting is 1X)
4. Press the OK button to confirm.

## 5.5 Alarm

1. Press the MENU button and the menu bar will pop up.
2. Press the ◀ LEFT button or ▶ RIGHT button until  Alarm Icon is highlighted.
3. Press the ▲ UP button or ▼ DOWN button to select the desired time from 2h, 4h, 6h and OFF. (The default setting is OFF)
4. Press the OK button to confirm.

## 5.6 Camera Control

### 5.6.1 Delete a camera

1. Press the MENU button and the menu bar will pop up.
2. Press the ◀ LEFT button or ▶ RIGHT button until  Cam icon is highlighted, and the del/add/view/scan menu will pop up.

3. Press the ▲ UP button or ▼ DOWN button to select the **DEL** icon, and press the OK button to confirm.
4. **cam 1 / cam 2 / cam 3 / cam 4** will pop up, press the ▲ UP button or ▼ DOWN button to select the desired CAM, and press the OK button to delete that registration on your Monitor Unit.

### NOTE

A CAM channel needs to be deleted before pairing to a new Camera Unit.

## 5.6.2 Add (pair) a camera

1. Press the MENU button and the menu bar will pop up.
2. Press the ◀ LEFT button or ▶ RIGHT button until  Cam icon is highlighted, and the del/add/view/scan menu will pop up.
3. Press the ▲ UP button or ▼ DOWN button to select **ADD** icon, and press the OK button to confirm.
4. **cam 1 / cam 2 / cam 3 / cam 4** will pop up, press the ▲ UP button or ▼ DOWN button to select the desired CAM, and press the OK button to start searching for a Camera Unit.
5. Press and hold the PAIR key underneath the Camera Unit for at least 3 seconds. The power LED light (green LED light, located directly below the camera lens aperture) should flash green to indicate the Camera Unit is in pairing mode. If it does not flash, press and hold the PAIR key until the LED light flashes.
6. If unsuccessful, delete the camera channel as per 5.6.1 on page 12, and attempt to pair again.

### NOTE

A Camera Unit can only be registered to one Monitor Unit at any one time.

## 5.6.3 View a camera

1. Press the MENU button and the menu bar will pop up.
2. Press the ◀ LEFT button or ▶ RIGHT button until  Cam icon is highlighted, and the del/add/view/scan menu will pop up.
3. Press the ▲ UP button or ▼ DOWN button to select **VIEW** icon, and press the OK button to confirm.
4. **cam 1 / cam 2 / cam 3 / cam 4** will pop up, press the ▲ UP button or ▼ DOWN button to select the desired Camera Unit to view.

### **TIP: Quick method to cycle through CAM channels**

Quick method to view desired camera instead of entering into the menu bar: directly press OK button to cycle through paired cameras: cam 1 / cam 2 / cam 3 / cam 4 / scan(x).

## 5.6.4 Scan camera

This function automatically cycles through your paired camera channels to display each camera for 10 seconds. This function is only useful if you have more than 1 Camera Unit paired.

1. Press the MENU button and the menu bar will pop up.
2. Press the ◀ LEFT button or ▶ RIGHT button until  Cam icon is highlighted, and the del/add/view/scan menu will pop up.
3. Press the ▲ UP button or ▼ DOWN button to select **SCAN** icon, and press the OK button to confirm.
4. The screen will then display the video from different paired cameras in a loop of **cam 1 / cam 2 / cam 3 / cam 4** , changing every 12 seconds.

### **NOTE**

When in Scan mode, the Monitor Unit will stop scanning and alert you if one of the Camera Unit is out of range or is not switched ON.

## 5.7 Warning Volume Setting

This controls the volume of an audio 'beep' sound from the Monitor Unit to alert you when the unit is low on battery or out of range.

1. Press the MENU button and the menu bar will pop up.
2. Press the ◀ LEFT button or ▶ RIGHT button until  Warning Volume icon is highlighted.
3. Press the ▲ UP button or ▼ DOWN button to select high / low / off.
4. Press the OK button to confirm.

## 6. Using Optical Lens

**Warning: Choking hazard. The Optical Lens (and Lens Hood) are small parts. Keep Camera Unit away from baby's reach at all times.**

**Always ensure that the lens are screwed tightly onto the Camera Unit.**

This product is the first-ever video monitor that offers Optical Lens compatibility, giving you more control over the viewing distance and viewing angle.

### 6.1 Aluminum Lens Hood

The Camera Unit comes fitted with a Lens Hood. This is an aluminum hood which protects the aperture of the Camera Unit. This setup provides a normal video effect.

### 6.2 Optical Zoom Lens

This Camera Unit offers both digital zoom and optical zoom. Unlike digital zoom, using the Optical Zoom Lens provides zooming without compromising picture clarity. It is recommended to use the optical zoom lens when closer to a specific point. If this is not enough, turn digital zoom to 2X to see even further.

### 6.3 Optical Wide Angle Lens

The Optical Wide Angle Lens (sold separately) is available to obtain a wider range of vision around the Camera Unit. These lens provide a zoomed-out effect, allowing you to see more around the Camera Unit. This setup is recommended for surveillance use or monitoring movement in playroom or large rooms.

Visit [www.infantoptics.com](http://www.infantoptics.com) to purchase your Optical Wide Angle Lens.

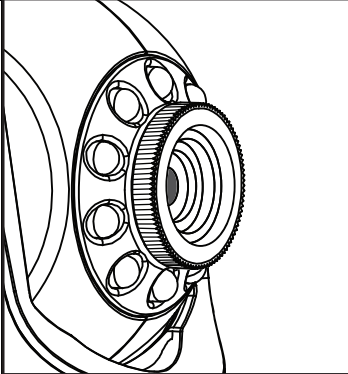
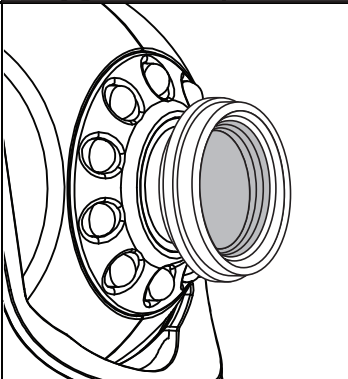
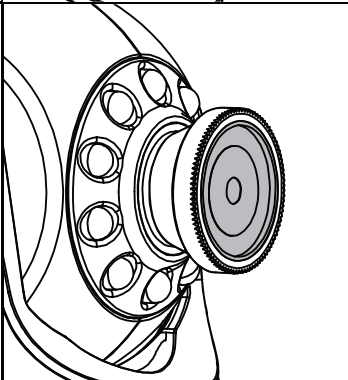
Lens Type	Image	Description
<p>Aluminum Lens Hood (default out of box)</p>		<p>Aluminum lens hood cover to protect camera lens. No special video effects. Recommended for normal settings.</p>
<p>Optical Zoom Lens</p>		<p>Telephoto lens zooms inward, resulting in objects appearing closer and enhancing the detail of objects at further distances. Recommended when Camera Unit is set up at a greater distance away from crib.</p>
<p>Optical Wide Angle Lens <i>(sold separately)</i></p>		<p>Zooms image outwards, allowing greater peripheral vision. Provides wide angle vision. Results in slight distortion and reduced clarity. Recommended for room activity surveillance.</p>

## 6.4 Cleaning your Optical Lens

Smudges and dust on the optical lens can diminish sharpness and reduce video quality. Remove smudges and dust on the lens by using a micro-fiber cloth or a piece of lens tissue to wipe the lens surface in a circular motion.

## 7. Troubleshooting

<p>Product does not switch on</p>	<ul style="list-style-type: none"> <li>* Confirm that the Camera and Monitor Unit are ON (check Power LED indicator).</li> <li>* The battery may be depleted; recharge or replace battery.</li> <li>* Confirm that power adapters are properly connected.</li> </ul>
<p>Reception interference (static)</p>	<ul style="list-style-type: none"> <li>* The Camera and Monitor Unit may be too far apart.</li> <li>* The battery power may be too low.</li> <li>* Other electronic devices may be interfering with the signal.</li> <li>* The Camera or Monitor Unit may be in close proximity to large metallic objects causing interference.</li> <li>* Use of other 2.4GHz products, such as wireless networks (WiFi routers), Bluetooth systems, or microwave ovens, may cause interference with this product. Keep Camera and Monitor Unit at least 5ft (1.5m) away from these items, or turn them off if they appear to cause interference.</li> </ul>
<p>Camera Unit loses link with the Monitor Unit</p>	<ul style="list-style-type: none"> <li>* If the Camera Unit is too far away with low reception, move the Camera Unit closer to the Monitor Unit.</li> <li>* Reset both units by disconnecting them from battery and electrical power. Wait about 15 seconds, then reconnect.</li> <li>* Large metallic objects, including doors, refrigerators, mirrors, filing cabinets, and also reinforced concrete, may block the radio signal if between the Camera and Monitor Unit.</li> <li>* The signal strength may be reduced when in close proximity to radio or electrical equipment, such as TVs, computers, cordless or mobile phones, fluorescent lights or dimmer switches.</li> <li>* Use of other 2.4GHz products, such as wireless networks (WiFi routers), Bluetooth systems, or microwave ovens, may cause interference with this product. Keep Camera and Monitor Unit at least 5ft (1.5m) away from these items, or turn them off if they appear to cause interference.</li> <li>* Pair the Camera Unit under a different channel. (refer to page 13, chapter 5.6.2)</li> </ul>
<p>No picture from a Camera Unit</p>	<ul style="list-style-type: none"> <li>* Check all connections to the camera. Confirm that the adapter is plugged in.</li> <li>* Try recharging or replacing the battery pack.</li> <li>* Confirm that all cameras and monitors are both ON.</li> </ul>

	<ul style="list-style-type: none"> <li>* Make sure that the Camera Unit is within range of the monitor.</li> <li>* Confirm that the Camera and Monitor Unit are paired.</li> <li>* Adjust the monitor antenna to vertical position.</li> </ul>
No sound from Monitor Unit	<ul style="list-style-type: none"> <li>* Volume setting may be too low. Adjust to a higher setting.</li> </ul>
Picture is black and white	<ul style="list-style-type: none"> <li>* Night vision LED may be ON. Night vision mode operates in black and white.</li> <li>* Turn on room lights to force monitor out of night vision mode.</li> </ul>
The picture playback is not smooth (choppy video with low frame rate)	<ul style="list-style-type: none"> <li>* Try moving the Camera Unit closer to the Monitor Unit.</li> <li>* Remove obstructions between the Camera and Monitor Unit.</li> <li>* Adjust the monitor antenna to vertical position.</li> <li>* Use of other 2.4GHz products, such as wireless networks (WiFi routers), Bluetooth systems, or microwave ovens, may cause interference with this product. Keep Camera and Monitor Unit at least 5ft (1.5m) away from these items, or turn them off if they appear to cause interference.</li> </ul>
Camera Unit power LED changes brightness	<ul style="list-style-type: none"> <li>* This is normal. The Power LED indicator is set to dim when in the dark, and brighten when ambient light is detected.</li> </ul>
Noise (static, beeping)	<ul style="list-style-type: none"> <li>* Battery power may be too low; recharge or replace battery.</li> <li>* Possible alarm ring alert.</li> <li>* Possible out of signal alert.</li> </ul>
Noise interference on your Monitor Unit	<ul style="list-style-type: none"> <li>* Volume may be set too high on the Monitor Unit. Lower volume.</li> <li>* The Camera and Monitor Units may be too close. Move them further apart.</li> <li>* The Camera Unit may be too far away and out of range. Move the Camera Unit closer to the Monitor Unit.</li> <li>* Make sure the Camera and Monitor Units are placed away from other electrical equipment, such as a television, computer or cordless/mobile telephone.</li> </ul>

<p>The rechargeable battery will not charge or no charge light</p>	<ul style="list-style-type: none"> <li>* The USB Output Adapter may not be properly connected.</li> <li>* Battery pack may not be properly connected inside the battery compartment. Reconnect the wire tab of battery.</li> <li>* Try using the other USB Power Cable included.</li> <li>* There may be no power from the USB outlet. Switch to another electrical outlet (if using USB Output Adapter) or another USB power source (if using computer/laptop USB power).</li> </ul>
<p>Pairing failed</p>	<ul style="list-style-type: none"> <li>* Make sure that the Power Adapter is connected to the Camera Unit.</li> <li>* Confirm that the Camera Unit is turned ON (Power LED indicator shows green light).</li> <li>* Try pairing to another CAM channel.</li> </ul>
<p>Video not clear with stagnant spots/marks on the screen</p>	<ul style="list-style-type: none"> <li>* Optical lens dirty. Follow 'Cleaning your Optical Lens' procedure. (Please refer to page 16, chapter 6.4)</li> </ul>

If the above troubleshooting guide did not help you solve your problem, contact customer service. Our toll-free number and customer service email address is located in the back of this User Manual.



## 8. Specifications

### Systems General

RF Frequency:	2400 Mhz ~ 2483.5 Mhz
Type of Modulation:	GFSK
Type of Spread Spectrum:	FHSS
Selectable Camera Channels:	4
Data Rate:	3 Mbps
Channel Bandwidth:	3.375 MHz
Transmission Range:	up to 700 feet (line of sight, no obstruction)

### Camera Unit

Input Voltage:	100-240VAC @ 50/60Hz
Operating Voltage:	5.9V, 1000mA
IR/Night Vision:	8 IR LEDs, 1 Low light sensor
Picture sensor:	GC0308 1/6.5' Color CMOS
Built-Lens:	f 2.5mm, F 2.8
Operating Temperature:	0° C (+32° F) to +50° C (122° F)
Power Adapter:	Input: 100-240VAC, 50/60Hz 200mA; Output: 5.9V, 1000mA
Exposure Control:	Auto
White Balance Control:	Auto
Vertical Turning Angle:	95° UP, 25° DOWN
Horizontal Turning Angle:	135° both left and right

### Monitor Unit

Input Voltage:	100-240VAC @ 50/60Hz
Operating Voltage:	5.0V, 500/550mA
Resolution (Pixel):	320 x 240
Battery:	1200mAH Li-ion 3.7V rechargeable battery
LCD Display:	3.5" TFT color display at 320 x 240 RGB colors
Power Adapter:	Input: 100-240VAC, 50/60Hz 200mA; Output: 5.0V, 500/550mA
Duration (Standby Mode):	10 Hours
Duration (Screen ON):	6 Hours
Time to charge full:	7 Hours

## 9. FCC Regulations

This equipment has been tested and found to comply with the limits for a Class B digital device, pursuant to Part 15 of FCC Rules. These limits are designed to provide reasonable protection against harmful interference in a residential installation. This equipment generates, uses, and can radiate radio frequency energy and, if not installed and used in accordance with the instructions, may cause harmful interference to radio communications. However, there is no guarantee that interference will not occur in a particular installation. If this equipment does cause harmful interference to radio or television reception, which can be determined by turning the equipment off and on, the user is encouraged to try to correct the interference by one or more of following measures:

- Reorient or relocate the receiving antenna.
- Increase the separation between the equipment and receiver.
- Connect the equipment into an outlet on a circuit different from that to which the receiver is connected.
- Consult the dealer or an experienced radio/TV technician for help.

Changes or modifications not expressly approved by the party responsible could void the user's authority to operate this device.

This device complies with part 15 of the FCC Rules. Operation is subject to the following two conditions:

1. This device may not cause harmful interference, and
2. This device must accept any interference received, including interference that may cause undesired operation.

This equipment complies with FCC Radiation Exposure Limits set forth for an uncontrolled environment. This equipment should be installed & operated between with minimum distance 20cm the radiator & your body.

## 10. Warranty Information

We warrant to the original user that this product shall be free from all defects in material or workmanship for one year from the date of purchase. This warranty does not apply to any product that has been subject to abuse, misuse, negligence or accident, nor does it apply to any batteries that may be supplied with the product. Defects caused by tampering, unauthorized alterations or repairs are not covered by this warranty. We may elect to replace the entire unit, at no extra cost to you, with the same model or a similar model rather than repair it. If a defect covered by this warranty should occur, email us with a scanned copy of your original receipt and a brief explanation of the problem, failing which Infant Optics will not perform any of its obligations under this warranty. Our service representative will provide you with an address of our closest office/warehouse to where you live, together with a return authorization number. To return the item, you must use the original packaging or the equivalent, and you must pay postage.

This limited warranty is valid only in the United States and applies only when this product is used in the United States.

OUTSIDE U.S.: This warranty does NOT apply to, and Infant Optics is not responsible for, any warranty claims made on products sold or used outside the United States.

### **TOLL FREE CUSTOMER SUPPORT**

1-800-291-0195

### **DEDICATED CUSTOMER SUPPORT EMAIL**

[info@infantoptics.com](mailto:info@infantoptics.com)

We will respond all inquiries within 24 hours.

This warranty gives you specific legal rights, and you may have other legal rights that vary from state to state.

2018 Infant Optics

All rights reserved.

